

Absolute Maximum Ratings		Values		Units
Symbol	Conditions ¹⁾	... 123 D	... 123 D1	
V _{CEs}		1200		V
V _{CGR}	R _{GE} = 20 kΩ	1200		V
I _C	T _{case} = 25/80 °C	200 / 180		A
I _{CM}	T _{case} = 25/80 °C; t _p = 1 ms	400 / 360		A
V _{GES}		± 20		V
P _{tot}	per IGBT, T _{case} = 25 °C	1380		W
T _J , (T _{stg})		- 40 ... +150 (125)		°C
V _{isol}	AC, 1 min.	2 500 ⁷⁾		V
humidity	DIN 40 040	Class F		
climate	DIN IEC 68 T.1	40/125/56		
Inverse Diode		FWD ⁶⁾		
I _F = - I _C	T _{case} = 25/80 °C	200 / 130	260 / 180	A
I _{FM} = - I _{CM}	T _{case} = 25/80 °C; t _p = 1 ms	400 / 360	400 / 360	A
I _{FSM}	t _p = 10 ms; sin.; T _J = 150 °C	1450	1800	A
I _t ²	t _p = 10 ms; T _J = 150 °C	10 500	24 200	A ² s

SEMITRANS® M IGBT Modules

SKM 200 GA 123 D ^{*)}
 SKM 200 GB 123 D
 SKM 200 GB 123 D1 ⁶⁾
 SKM 200 GAL 123 D ⁶⁾
 SKM 200 GAR 123 D ⁶⁾

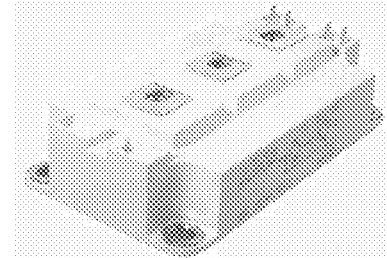

SEMITRANS 3

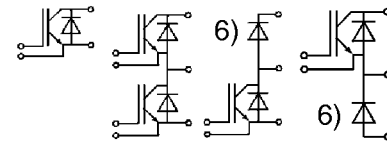

GA GB GAL GAR

Features

- MOS input (voltage controlled)
- N channel, Homogeneous Si
- Low inductance case
- Very low tail current with low temperature dependence
- High short circuit capability, self limiting to 6 * I_{cnom}
- Latch-up free
- Fast & soft inverse CAL diodes ⁸⁾
- Isolated copper baseplate using DCB Direct Copper Bonding Technology
- Large clearance (13 mm) and creepage distances (20 mm).

Typical Applications: → B6 - 153

- Switching (not for linear use)

Characteristics		min.	typ.	max.	Units
Symbol	Conditions ¹⁾				
V _{(BR)CES}	V _{GE} = 0, I _C = 4 mA	≥ V _{CEs}	-	-	V
V _{GE(th)}	V _{GE} = V _{CE} , I _C = 6 mA	4,5	5,5	6,5	V
I _{CEs}	V _{GE} = 0 } T _J = 25 °C	-	0,2	3	mA
		V _{CE} = V _{CEs} } T _J = 125 °C	-	12	-
I _{GES}	V _{GE} = 20 V, V _{CE} = 0	-	-	1	μA
V _{CEsat}	I _C = 150 A } V _{GE} = 15 V;	-	2,5(3,1)	3(3,7)	V
V _{CEsat}	I _C = 200 A } T _J = 25 (125) °C	-	2,8(3,6)	-	V
g _{fs}	V _{GE} = 20 V, I _C = 150 A	95	-	-	S
C _{CHC}	per IGBT	-	-	700	pF
C _{ies}	V _{GE} = 0 } V _{CE} = 25 V } f = 1 MHz	-	10	13	nF
C _{oes}		-	1,5	2	nF
C _{res}		-	0,8	1,2	nF
L _{CE}		-	-	20	nH
t _{d(on)}	V _{CC} = 600 V } V _{GE} = -15 V / +15 V ³⁾ } I _C = 150 A, ind. load } R _{Gon} = R _{Goff} = 5,6 Ω } T _J = 125 °C	-	220	400	ns
t _r		-	100	200	ns
t _{d(off)}		-	600	800	ns
t _f		-	70	100	ns
E _{on} ⁵⁾		-	24	-	mWs
E _{off} ⁵⁾	-	17	-	mWs	
Inverse Diode ⁸⁾					
V _F = V _{EC}	I _F = 150 A } V _{GE} = 0 V; } I _F = 200 A } T _J = 25 (125) °C	-	2,0(1,8)	2,5	V
V _F = V _{EC}		-	2,25(2,05)	-	V
V _{TO}	T _J = 125 °C	-	-	1,2	V
r _T	T _J = 125 °C	-	5	7	mΩ
I _{RRM}	I _F = 150 A; T _J = 25 (125) °C ²⁾	-	55(80)	-	A
Q _{rr}	I _F = 150 A; T _J = 25 (125) °C ²⁾	-	8(20)	-	μC
FWD of types "GAL", "GAR" "123D1" ⁸⁾ ⁶⁾					
V _F = V _{EC}	I _F = 150 A } V _{GE} = 0 V; } I _F = 200 A } T _J = 25 (125) °C	-	1,85(1,6)	2,2	V
V _F = V _{EC}		-	-	2,0(1,8)	-
V _{TO}	T _J = 125 °C	-	-	1,2	V
r _T	T _J = 125 °C	-	3	5,5	mΩ
I _{RRM}	I _F = 150 A; T _J = 25 (125) °C ²⁾	-	60(90)	-	A
Q _{rr}	I _F = 150 A; T _J = 25 (125) °C ²⁾	-	8(23)	-	μC
Thermal Characteristics					
R _{thjc}	per IGBT	-	-	0,09	°C/W
R _{thjc}	per diode / FWD "GAL; GAR"	-	-	0,25/0,18	°C/W
R _{thch}	per module	-	-	0,038	°C/W

1) T_{case} = 25 °C, unless otherwise specified

2) I_F = - I_C, V_R = 600 V, - di_F/dt = 1500 A/μs, V_{GE} = 0 V

3) Use V_{GEoff} = -5 ... -15 V

5) See fig. 2 + 3; R_{Goff} = 5,6 Ω

6) The free-wheeling diodes of the GAL and GAR types have the data of the inverse diodes of SKM 300 GA 123 D

7) V_{isol} = 4000 V_{rms} on request

8) CAL = Controlled Axial Lifetime Technology.

Cases and mech. data → B6-154

*) SEMITRANS 4 → B6-168

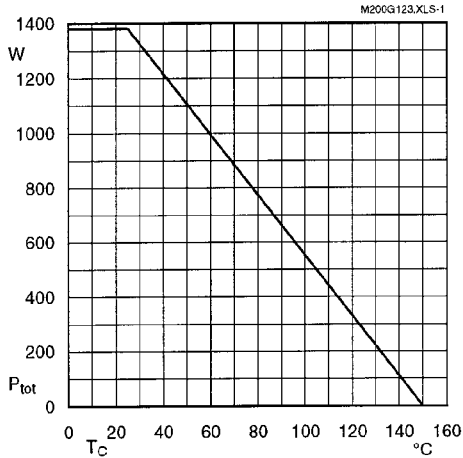

Fig. 1 Rated power dissipation $P_{tot} = f(T_C)$

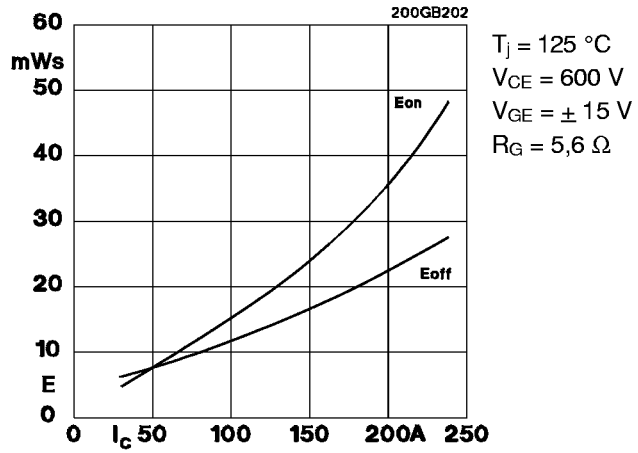

Fig. 2 Turn-on /-off energy $= f(I_C)$

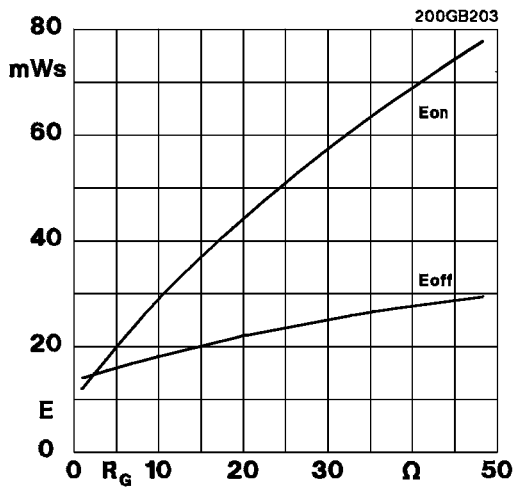

Fig. 3 Turn-on /-off energy $= f(R_G)$

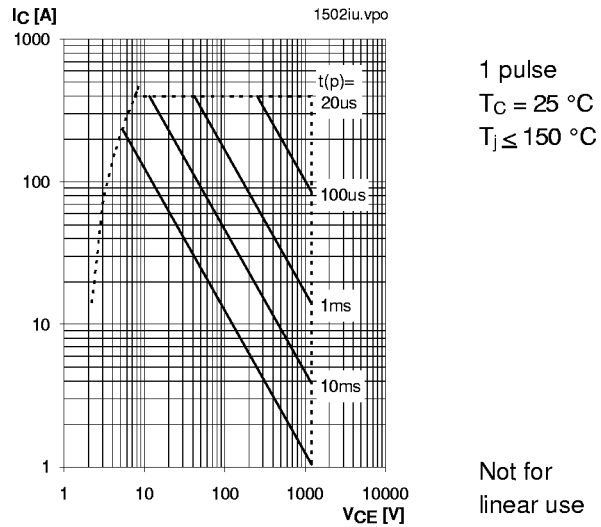

Fig. 4 Maximum safe operating area (SOA) $I_C = f(V_{CE})$

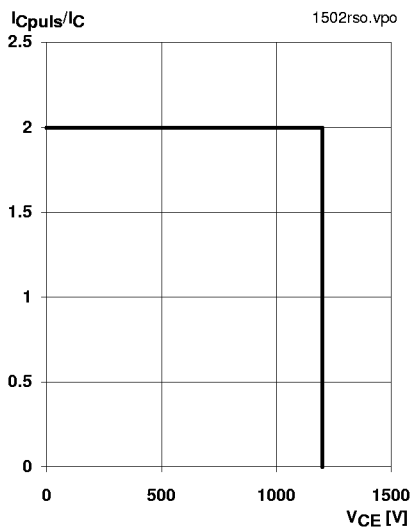

Fig. 5 Turn-off safe operating area (RBSOA)

$T_j \leq 150\text{ }^\circ\text{C}$
 $V_{GE} = 15\text{ V}$
 $R_{Goff} = 5,6\ \Omega$
 $I_C = 150\text{ A}$

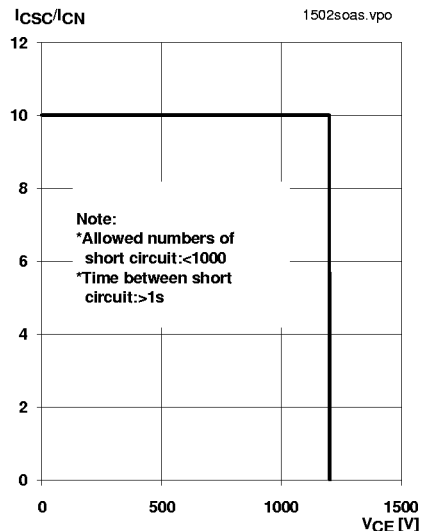

Fig. 6 Safe operating area at short circuit $I_C = f(V_{CE})$

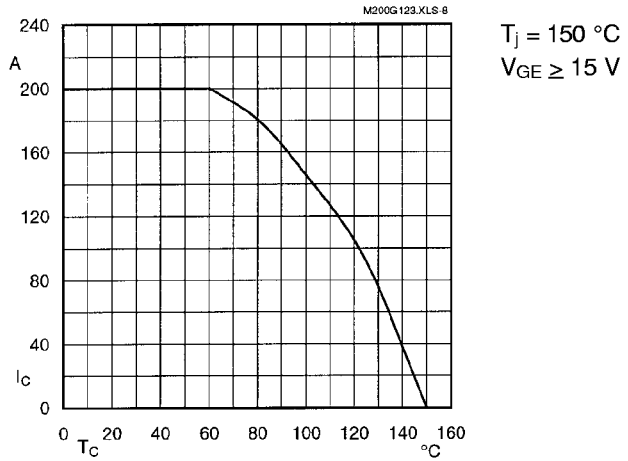

Fig. 8 Rated current vs. temperature $I_C = f(T_C)$

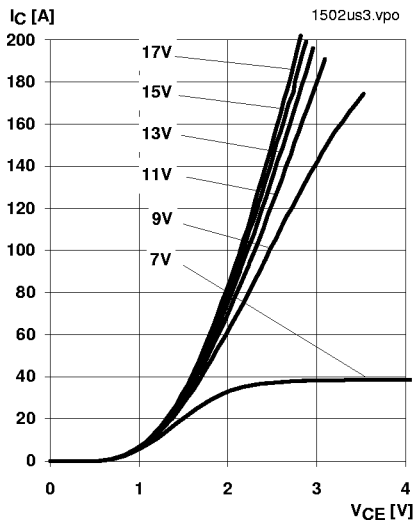

Fig. 9 Typ. output characteristic, $t_p = 80\text{ }\mu\text{s}$; $25\text{ }^\circ\text{C}$

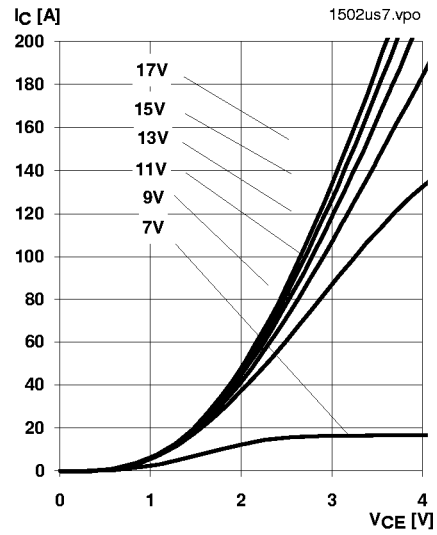

Fig. 10 Typ. output characteristic, $t_p = 80\text{ }\mu\text{s}$; $125\text{ }^\circ\text{C}$

$$P_{\text{cond}(t)} = V_{CE\text{sat}(t)} \cdot I_C(t)$$

$$V_{CE\text{sat}(t)} = V_{CE(TO)(T_j)} + r_{CE(T_j)} \cdot I_C(t)$$

$$V_{CE(TO)(T_j)} \leq 1,5 + 0,002 (T_j - 25) \text{ [V]}$$

$$\text{typ.: } r_{CE(T_j)} = 0,0066 + 0,000027 (T_j - 25) \text{ } [\Omega]$$

$$\text{max.: } r_{CE(T_j)} = 0,0100 + 0,000033 (T_j - 25) \text{ } [\Omega]$$

$$\text{valid for } V_{GE} = +15 \frac{+2}{-1} \text{ [V]; } I_C > 0,3 I_{C\text{nom}}$$

Fig. 11 Saturation characteristic (IGBT)
Calculation elements and equations

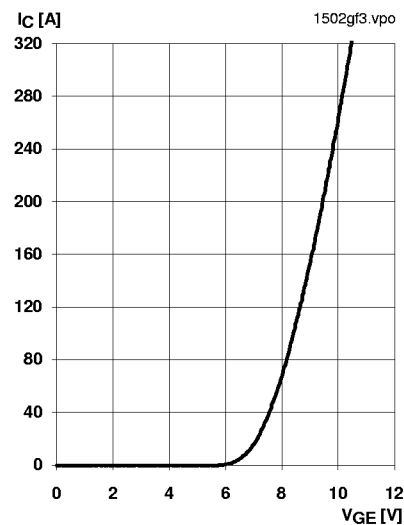

Fig. 12 Typ. transfer characteristic, $t_p = 80\text{ }\mu\text{s}$; $V_{CE} = 20\text{ V}$

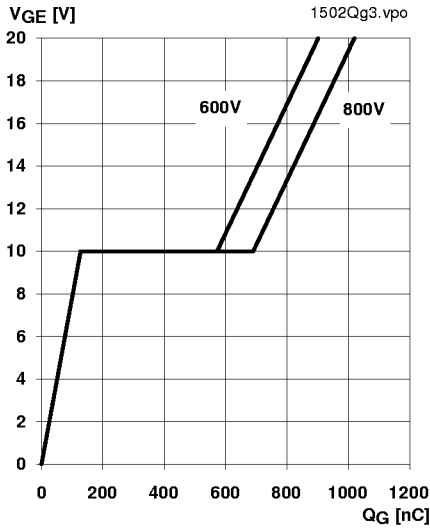

Fig. 13 Typ. gate charge characteristic

$I_{Cpuls} = 150 \text{ A}$

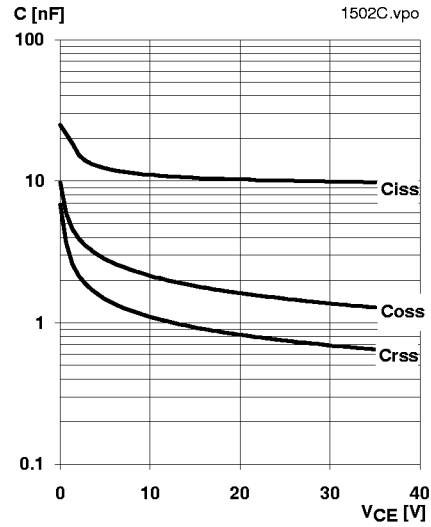

Fig. 14 Typ. capacitances vs. V_{CE}

$V_{GE} = 0 \text{ V}$
 $f = 1 \text{ MHz}$

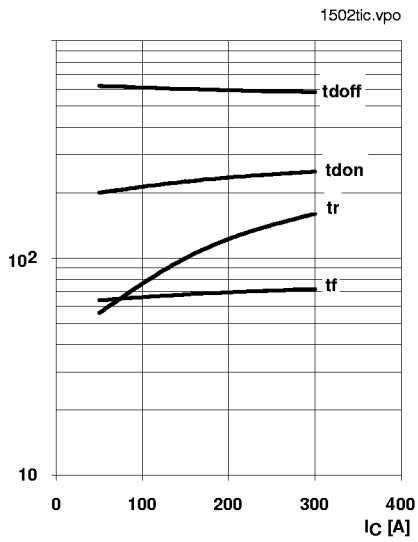

Fig. 15 Typ. switching times vs. I_C

$T_j = 125 \text{ }^\circ\text{C}$
 $V_{CE} = 600 \text{ V}$
 $V_{GE} = \pm 15 \text{ V}$
 $R_{Gon} = 5,6 \text{ } \Omega$
 $R_{Goff} = 5,6 \text{ } \Omega$
induct. load

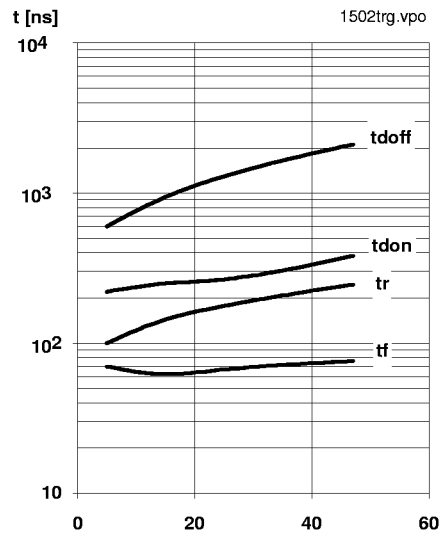

Fig. 16 Typ. switching times vs. gate resistor R_G

$T_j = 125 \text{ }^\circ\text{C}$
 $V_{CE} = 600 \text{ V}$
 $V_{GE} = \pm 15 \text{ V}$
 $I_C = 150 \text{ A}$
induct. load

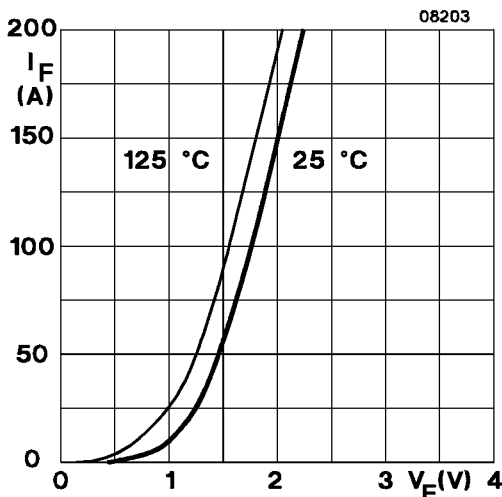

Fig. 17 Typ. CAL diode forward characteristic

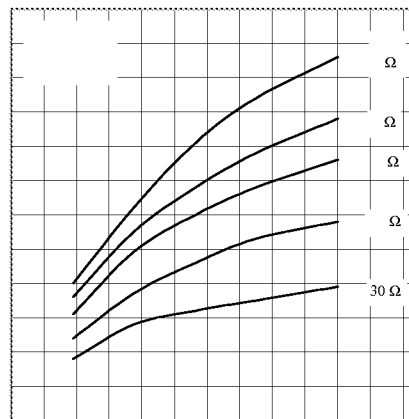

Fig. 18 Diode turn-off energy dissipation per pulse

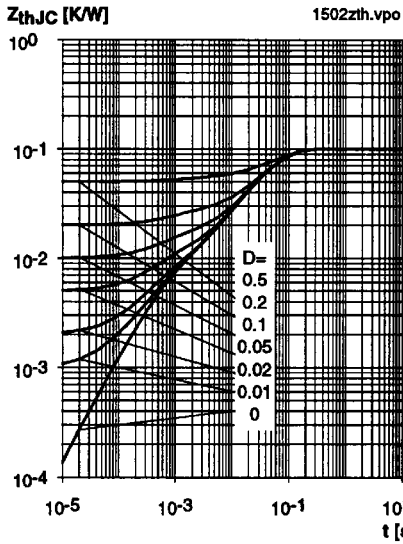

Fig. 19 Transient thermal impedance of IGBT
 $Z_{thJC} = f(t_p)$; $D = t_p / t_c = t_p \cdot f$

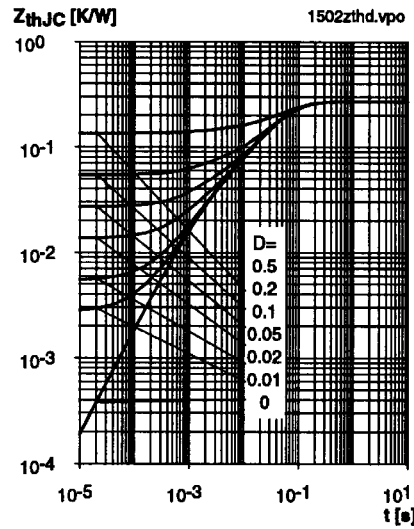

Fig. 20 Transient thermal impedance of inverse CAL diodes
 $Z_{thJC} = f(t_p)$; $D = t_p / t_c = t_p \cdot f$

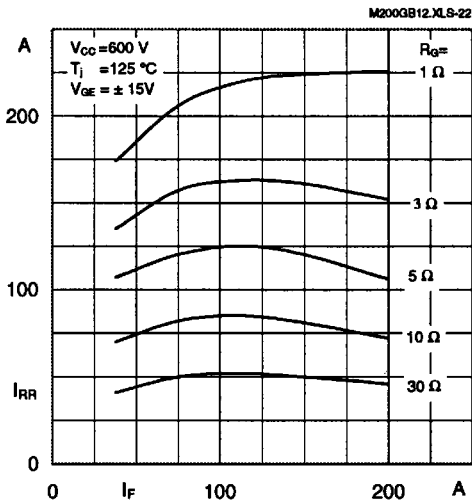

Fig. 22 Typ. CAL diode peak reverse recovery current $I_{RR} = f(I_F, R_G)$

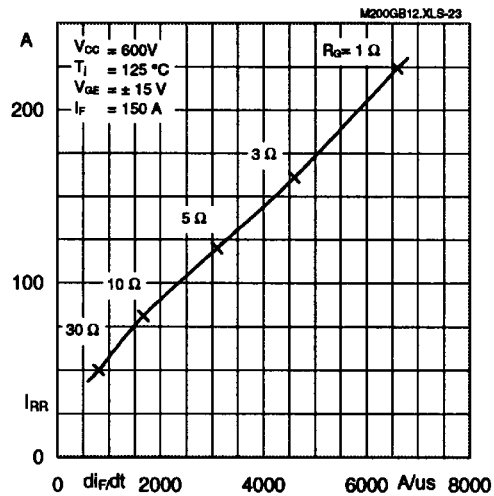

Fig. 23 Typ. CAL diode peak reverse recovery current $I_{RR} = f(di_F/dt)$

Typical Applications

include

- Switched mode power supplies
- DC servo and robot drives
- Inverters
- DC choppers (versions GAR; GAL)
- AC motor speed control
- Inductive heating
- UPS Uninterruptable power supplies
- General power switching applications

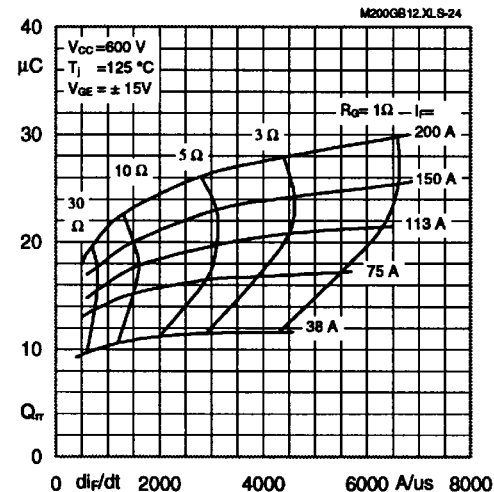
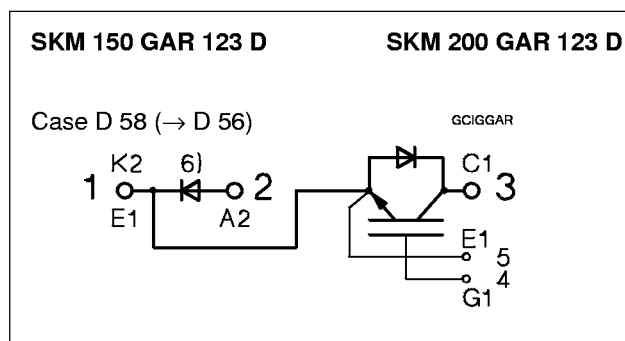
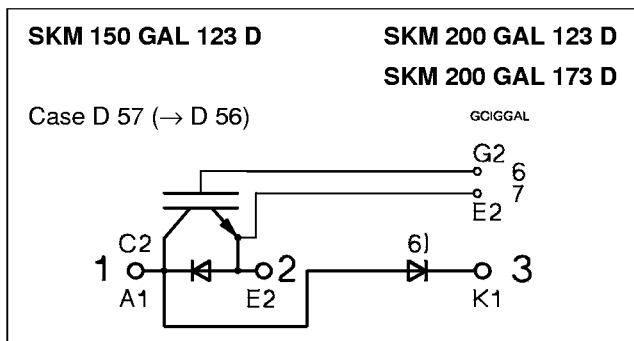
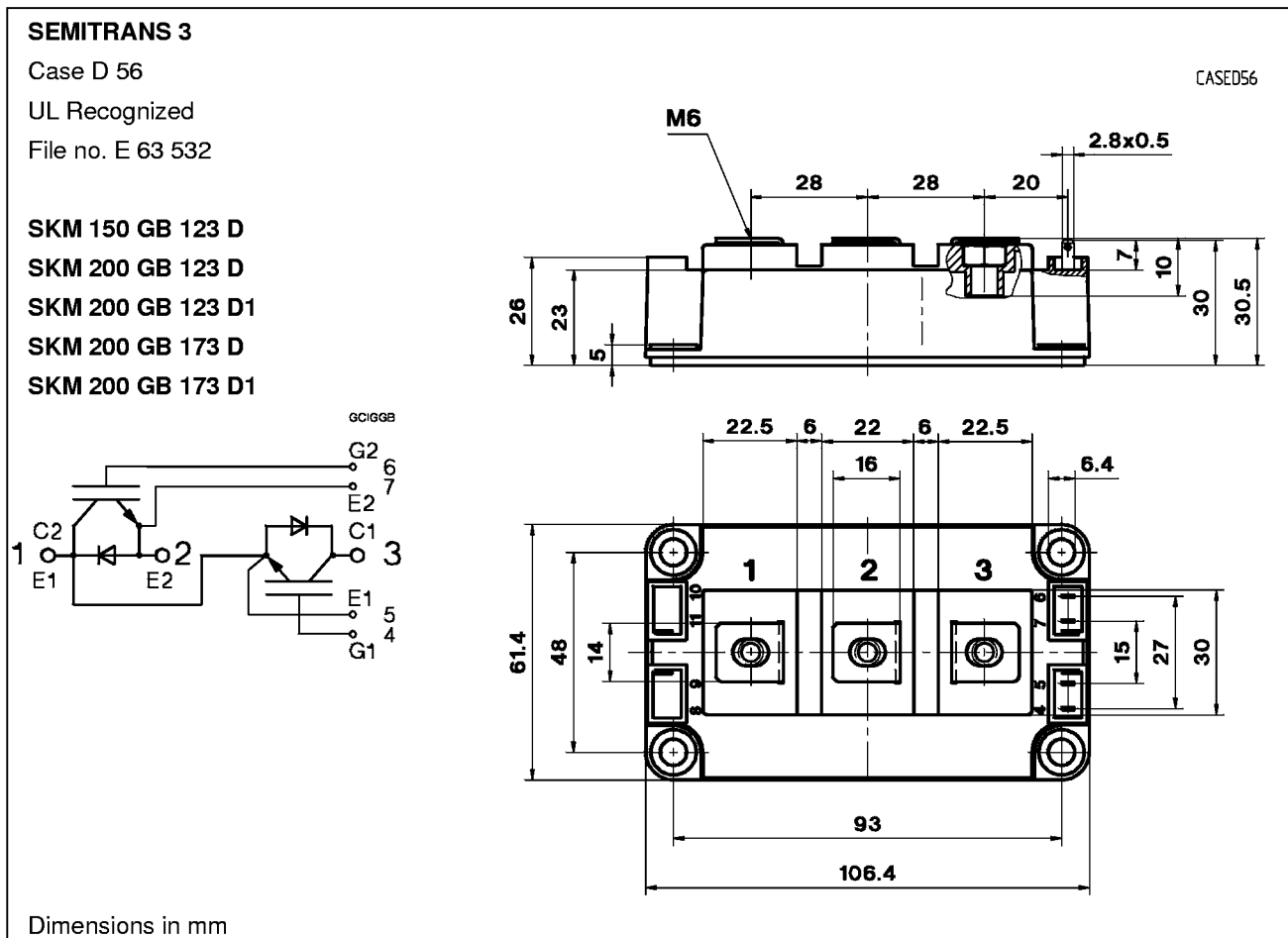

Fig. 24 Typ. CAL diode recovered charge $Q_{RR}=f(di/dt)$



Case outline and circuit diagrams

For SKM 200 GA 123 D (SEMISTRANS 4) → B 6 - 168

Mechanical Data			Values			Units
Symbol	Conditions		min.	typ.	max.	
M ₁	to heatsink, SI Units	(M6)	3	—	5	Nm
	to heatsink, US Units		27	—	44	lb.in.
M ₂	for terminals, SI Units	(M6)	2,5	—	5	Nm
	for terminals US Units		22	—	44	lb.in.
a			—	—	5x9,81	m/s ²
w			—	—	325	g

This is an electrostatic discharge sensitive device (ESDS). Please observe the international standard IEC 747-1, Chapter IX.

Three devices are supplied in one SEMIBOX A without mounting hardware, which can be ordered separately under Ident No. 33321100 (for 10 SEMISTRANS 3). Larger packing units of 12 and 20 pieces are used if suitable
 Accessories → B 6 - 4.
 SEMIBOX → C - 1.

⁶⁾ Freewheeling diode → B 6 - 149, remark 6.